

Standard: 2300/3200⁺²⁰ mm

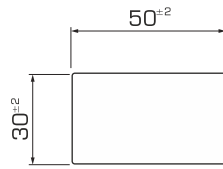

4x35 A2

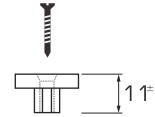

6x80mm



Kit 1m²

- 7,0 ml
- 3,5 ml
- 25 un.

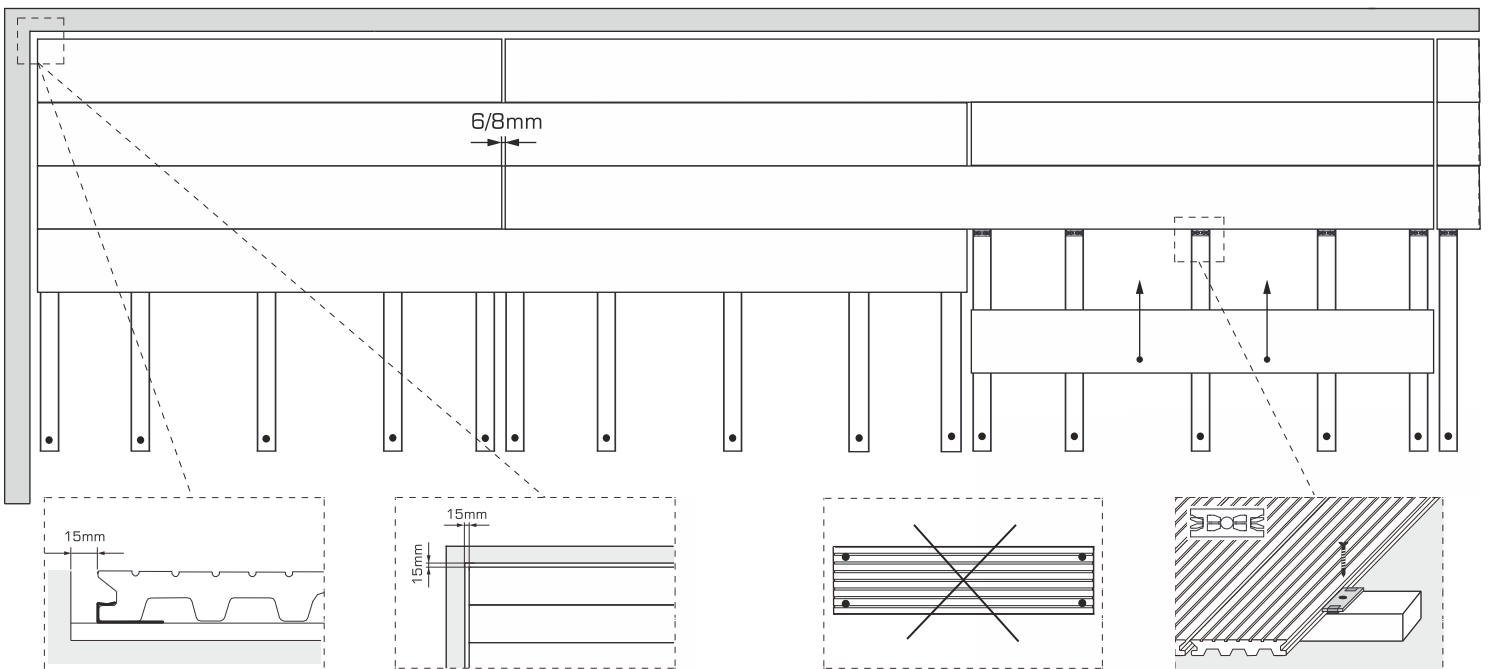
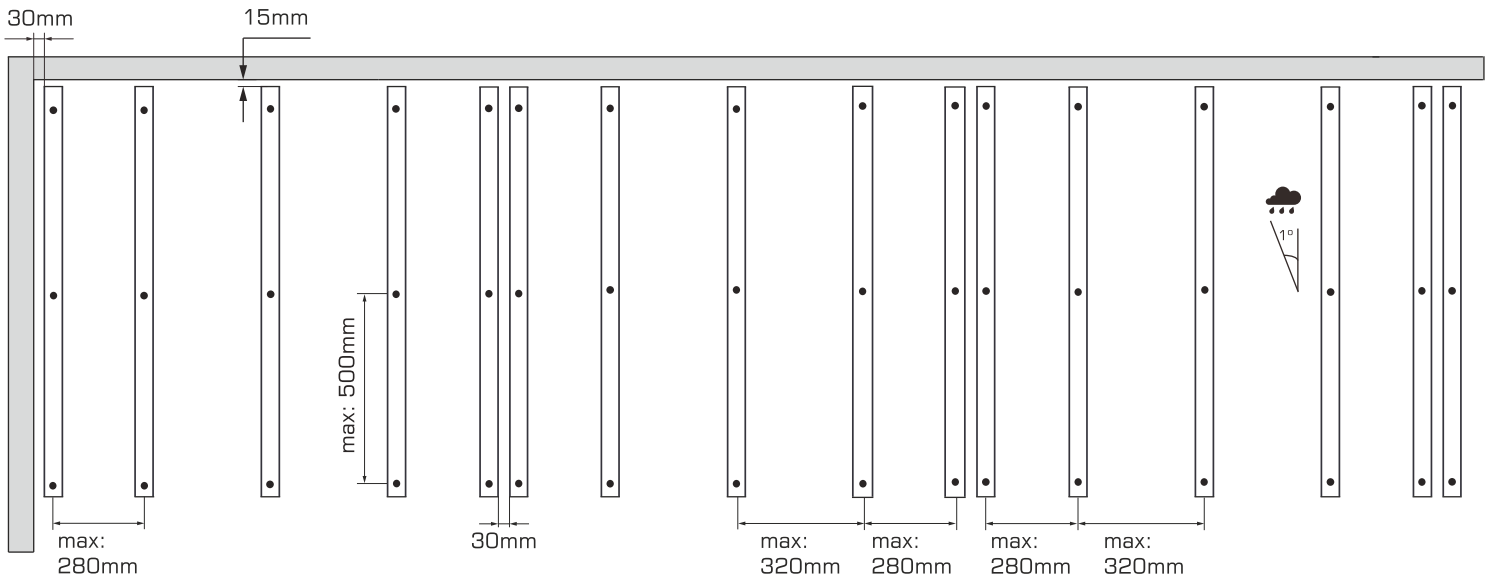
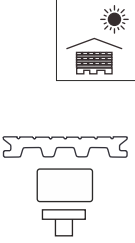

i

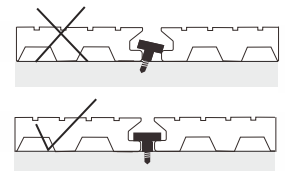
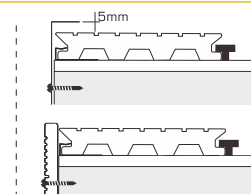
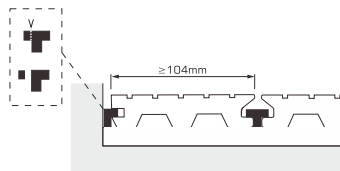
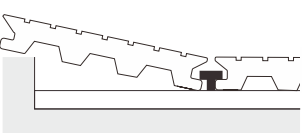

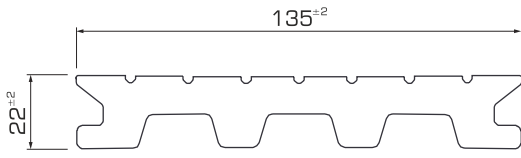
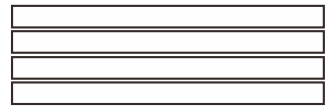

Standard: 2300/3200^{+0/-30} mm

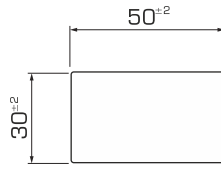

4x35 A2

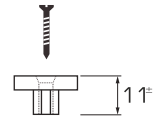

6x80mm



Kit 1m²

7,0 ml

3,5 ml

25 un.

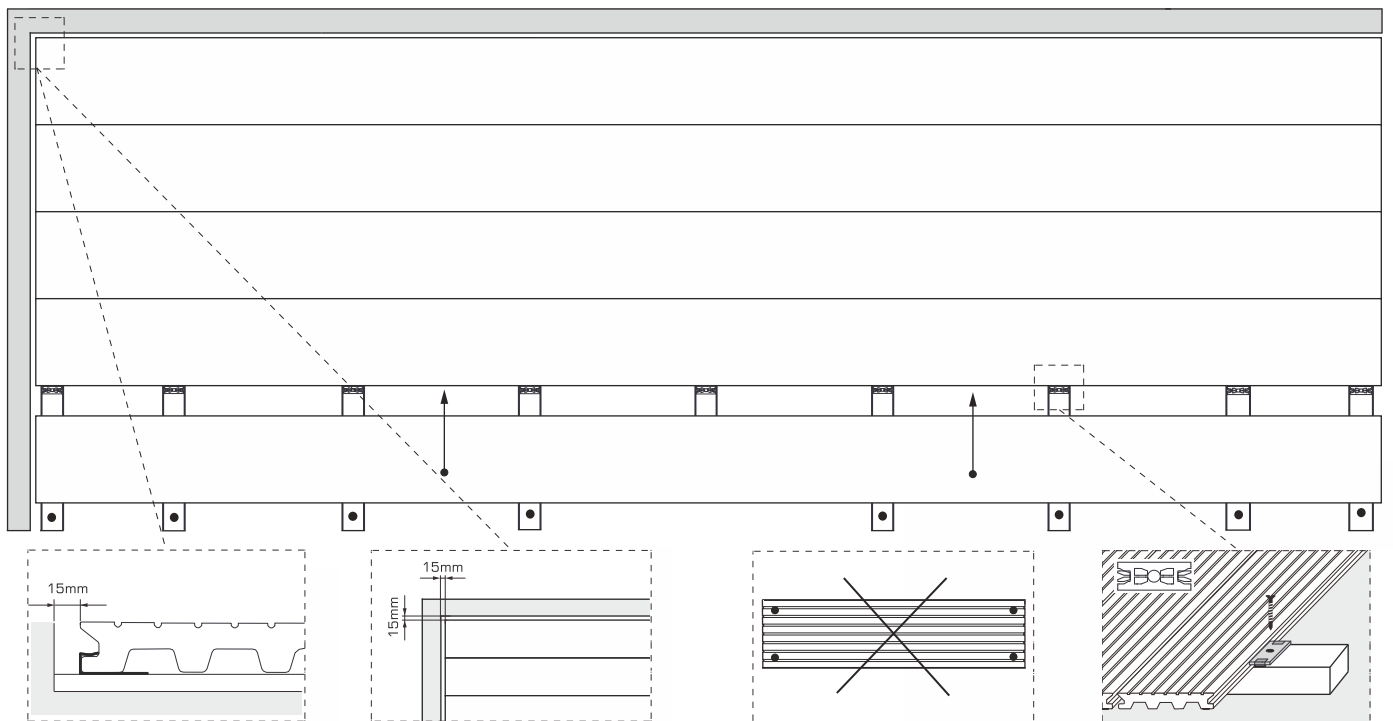
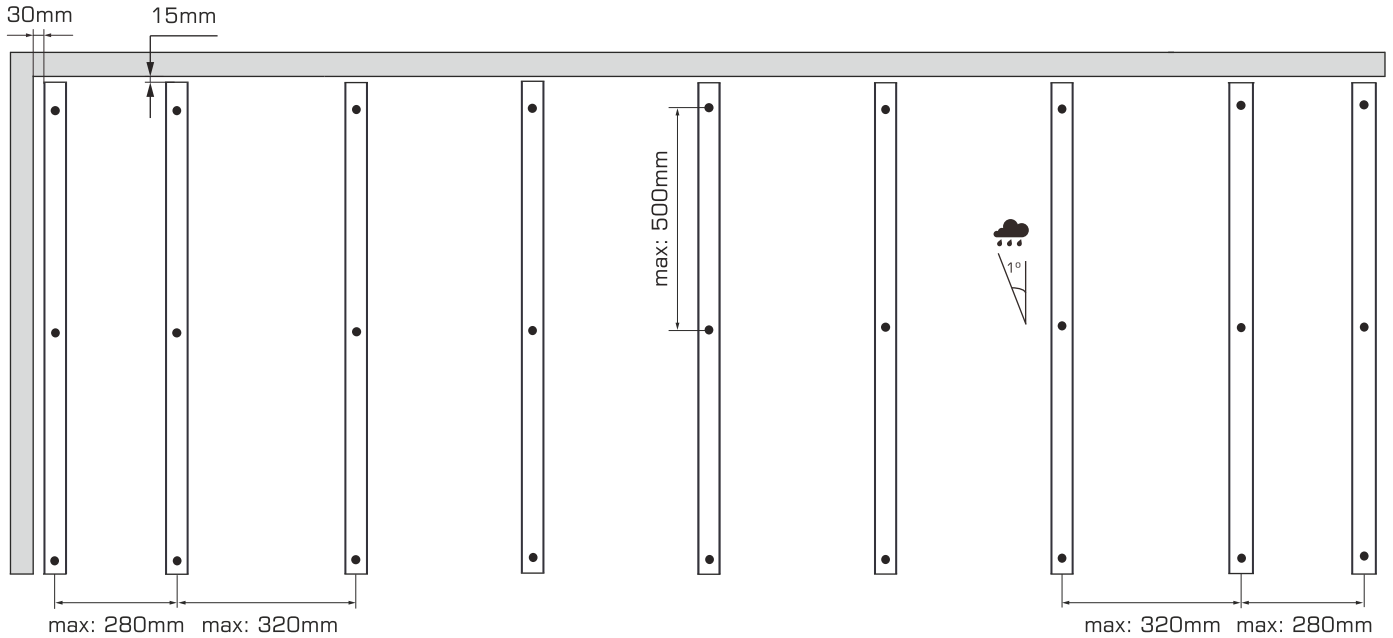
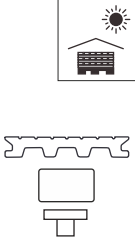

i

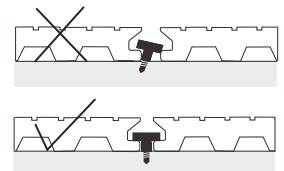
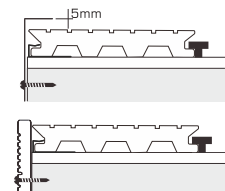
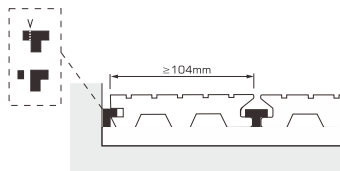
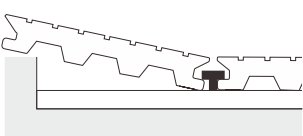

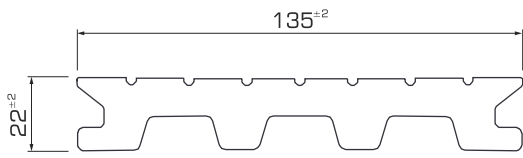

Standard: 2300/3200⁺²⁰ mm

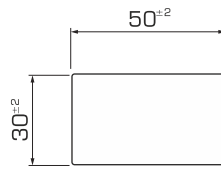

4x35 A2

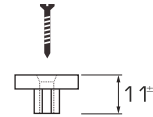

6x80mm



Kit 1m²

7,0 ml

3,5 ml

25 un.

